

DR. H. M. KARARA*
University of Illinois
Urbana, Ill. 61801

Universal Stereometric Systems

The market is ripe for an improved camera system whose introduction will surely have an important impact in many engineering and scientific disciplines.

(Abstract on next page)

1. INTRODUCTION

IN STRUCTURAL ENGINEERING, experimental research on model structures is often used to determine material properties and design criteria. In the direct approach such criteria are deduced from strain measurements. Strain gauges, however, fail to register in the plastic range of loading, and thus strain measurements have to be limited to the elastic range of loading. Fortunately, under relatively small loads, the tested material (steel, reinforced concrete, etc.) can be considered to have elastic properties (Wood, 1961). Elastic design criteria, however, are of restricted value, inasmuch as they are not valid for greater loads under which the plastic properties of the tested material become pronounced. Unfortunately, this is always the case near the yield point.

This being the case, structural engineering often makes use of deflection measurements of the structural model for an indirect and much more reliable determination of design criteria. Dial indication gauges of 0.001-inch reliability (accuracy) are generally used in deflection measurements. In a few cases, gauges of 0.0001-inch reliability are used. Obviously, the measurement of deflection should be rapid to reduce, as much as possible, the unfavorable effect of changes due to settling of the structure during the measurement.

Photogrammetry is ideally suited for this purpose. Photogrammetric techniques have several important advantages over the methods of direct measurement of deformations: (a) not having to disturb the object by

physical measurements; (b) with adequate preparations, the data acquisition phase could be undertaken in a matter of seconds; (c) the photographs provide permanent metrical records which could be consulted at any time for checking purposes or for additional measurements or information; and (d) having no accessibility problems for the measurement itself.

2. STEREOMETRIC CAMERAS†

Stereometric approaches are especially well suited for data acquisition in connection with deformation measurements, particularly under dynamic loading. Among the attractive features of such approaches are the simplicity and portability of the system, the possibility of simultaneous exposures, and the

† Stereometric cameras are essentially composed of two complete cameras (metric chambers) rigidly mounted to a base of definite length.

* Presented at the Annual Convention of the American Society of Photogrammetry, Washington, D. C., March 1967. In the interest of brevity the complete paper is not reproduced here; those interested in further details should request them from the author.—*Editor*.



H. M. KARARA

ability to record a situation in a fraction of a second. Stereometric cameras are, in general compact instruments and this fact in itself is an important factor in as much as no elaborate arrangements on the test floor are required which sometimes might interfere with the operations in the immediate neighborhood of the test area. In the stereometric approaches, one or more stereometric camera(s) is used for data acquisition.

Of the two photogrammetric approaches currently used for data reduction (the analogue and the analytical), the latter has shown an ever-increasing promise in recent years because of two important advantages:

stereometric camera developed in Poland and used extensively in precise mine surveys (Kowalczyk, 1964).

3. THE ORIGINAL MISSION

Fully recognizing the potentialities of the stereometric approach, the structural group of the Department of Civil Engineering of the University of Illinois requested in 1964 the cooperation of the photogrammetric group with respect to the use of metrical photography and the development of data acquisition processes for strains and deflections measurement of structural models under testing conditions.

ABSTRACT: Experimental studies have been conducted at the University of Illinois to assess the potentialities of the stereometric systems in conjunction with the measurement of deformations of structural models under test conditions. Some of the major factors that limit the precision and capabilities of current stereometric cameras have been determined. In the light of the results of experimental tests and theoretical investigations, definite modifications in the classical stereometric approaches are needed to enhance the precision of such systems to meet the high level of accuracy generally required in structural experimental research, quality control, and in several other engineering and scientific fields.

- (1) increased accuracy of measurements; and
- (2) increased flexibility of procedures.

To simplify the entire process of data acquisition and data reduction, the few stereometric cameras currently commercially available are generally limited to the conditions of the normal case of stereophotogrammetry: camera axes horizontal, parallel, and orthogonal to the base connecting the two camera positions. Among the commercially available stereometric cameras are: WILD C-120, WILD C-40, ZEISS SMK-40, ZEISS SMK-120, the GALILEO Veroplast, and the GALILEO Technoster.

In general, the use of stereometric cameras has been limited to fields involving medium- and low-precision requirements. Stereometric cameras are currently regarded as standard tools in such fields as traffic accident investigations, criminology, archeology, architecture, animal husbandry, etc.

Because of the attractiveness of the stereometric camera systems and, perhaps more important—the relative inexpensiveness of such cameras, efforts have been made in recent years to adapt these systems for use in fields of high accuracy requirements. One of the fine examples in this connection is the

The specific initial task was in conjunction with the structural group's research on "Yield Criteria of Reinforced Concrete under Biaxial Moments and Loads," and involved the precision determination of the z deformations and the x - and y -in-plane displacements of a reinforced concrete slab $84 \times 42 \times 4$ inches being loaded until failure under two schemes of loading as shown in Figure 1 and 2. The accuracy requirement specified maximum standard deviations of ± 0.1 mm in x ; y ; and z -coordinates of points throughout the slab.

Because of the attractiveness of the stereometric camera approach, and in spite of our awareness that recent results obtained by Konecny (1965), Wasil & Merchant (1964), and others, seemed to indicate that such an approach might not fully satisfy the accuracy requirements in our case, it was decided to start with a stereometric camera and modify it, if needed, to fulfill the requirements. A base of 40 cm length was deemed more suitable than that of 120 cm. This constraint narrowed the choice to three commercial cameras (WILD C-40, ZEISS SMK-40, and Galileo Stereoaographic Camera). It was further considered that glass plates would be preferable over films in view of eventual

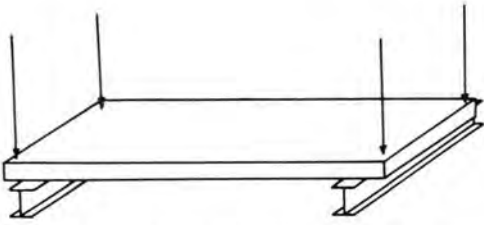

FIG. 1. Load scheme in bending tests. The arrows indicate the direction of forces applied.

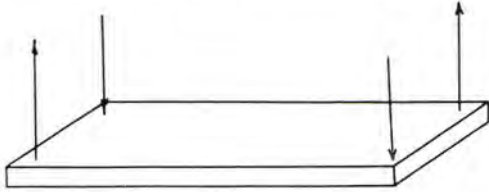

FIG. 2. Load scheme in torsion tests. The arrows indicate the direction of forces applied.

irregular film distortion. Thus, the field was limited to a choice between ZEISS SMK-40 and WILD C-40. In 1964, the ZEISS SMK-40 was the only one of the two cameras which could be promised for delivery within a reasonable period of time, and this played a decisive role in our decision to choose it as the core of our data acquisition system.

3.1. TEST APPARATUS

A sketch of the slab-testing apparatus is given in Figure 3. The stereometric camera was positioned atop the structure in a mounting yolk approximately 2.5 m above the slab which was to be tested. The optical axes of the camera were held in a vertical direction, with the Y axis (Figure 6) pointing downwards. The camera has a base of 40 cm and the lenses have nominal focal lengths of 60 mm, and a fixed aperture of $f/11$. Synchronized shutters vary exposures from 1 to

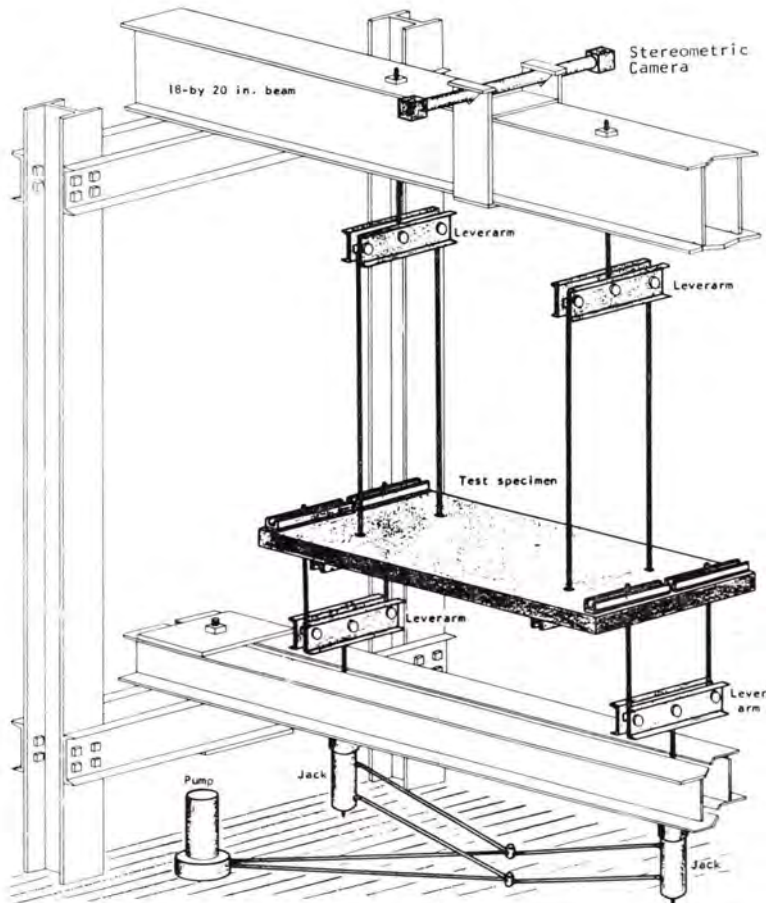

FIG. 3. Loading and supporting system for the bending tests (after Lenschow & Sozen, 1966).

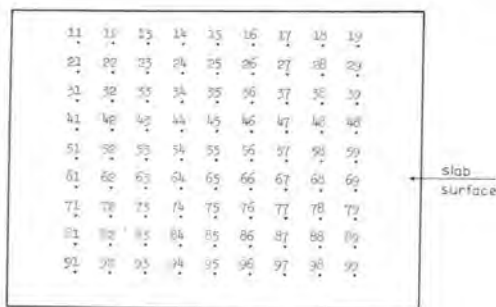

FIG. 4. Distribution of target points.

1/400 sec. 9 cm \times 12 cm metallographic glass plates of 1.25 mm thickness, ASA = 50, were used. The photographs were observed on a WILD STK-1 Stereocomparator, which has a least read-out count of 1 micron. The stereocomparator provided the data typed on paper and simultaneously punched on IBM cards.

The loading and supporting systems in case of bending tests (refer to Figure 1) are shown in Figure 3. With minor modifications in the loading and supporting systems, the same apparatus was used for the torsion tests (refer to Figure 2).

A matrix of 81 points was marked on a 40-inch square on the surface of reinforced concrete slab as shown in Figure 4. Gummed reinforcements, as shown in Figure 5, of an off-white color were used as targets.

3.2. THREE-DIMENSIONAL TRANSFORMATION

It might be of interest to discuss briefly the matters of control and absolute orientation in this project. The slab was not rigidly fixed in any position, and it actually moved (changing its position and *altitude*) as the loads were being applied. Moreover, the structural

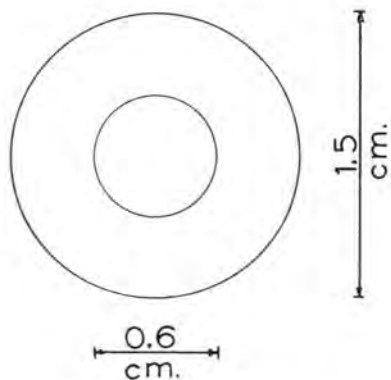

FIG. 5. Markers (targets).

model underwent deformations in x , y , and z under the different loads (Figure 3). Taking these two factors into consideration, and in view of the fact that the structural group was interested only in the deformations in x , y , and z , it seemed to our group that there was no point in securing fixed control beyond the slab being tested.

In each series of tests, a stereomodel was taken before any load had been applied (zero load) and after each step of loading until failure. In order to determine the deformations for each step of loading, the spatial model coordinates for every load were transformed into the model coordinate system of the zero load.

Because of the lack of fixed control, the regular photogrammetric orthogonal transformation (absolute orientation) could not be used in this case. Instead, a three-dimensional conformal transformation based on a system of axes which could move or *float* together with the slab was chosen. This type of coordinate transformations, used often by structural engineers, is based on one point, to be used as origin, and two lines intersecting at this point (Appostol, 1962, pp. 246-270). In Figure 7, the transformation system is defined by Lines 1 and 2 passing through points B and C , and intersecting in point A which will be considered as origin. Point P is a general point whose coordinates X_p, Y_p, Z_p in the original (camera space) coordinate system are to be transformed into the new system of coordinates x', y', z' . Formulas in the reference publication (Karara *et al.*, 1968) explicitly define the relationship between the two systems of coordinates.

3.3 EVALUATION OF THE SYSTEM

To evaluate the overall accuracy of the system, three sets of five stereo loadings each were taken at three successive loadings in one of

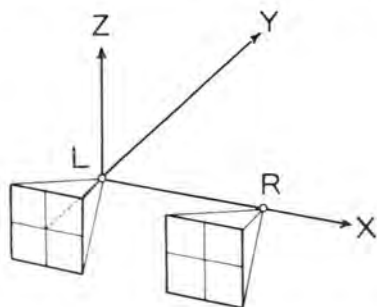

FIG. 6. Camera coordinate system. In the test apparatus described in Section 3.1 the Y -axis took a vertical direction pointing downward.

the tests. The first stereomodel taken for zero load was chosen as reference, and the spatial coordinates of all other models were transformed to this reference coordinate system using the previously described method. The variations in the deduced x -, y -, and z -coordinates of the 81 points were used to estimate the standard errors in the determination of the spatial coordinates (in model coordinate system). The results were as follows:

$$\begin{aligned} \sigma_{x_{\text{average}}} &= \pm 0.42 \text{ mm}, & \sigma_{y_{\text{av.}}} &= \pm 0.32 \text{ mm}, \\ \sigma_{z_{\text{av.}}} &= \pm 0.75 \text{ mm} \\ \sigma_{x_{\text{ii,maximum}}} &= \pm 0.62 \text{ mm}, & \sigma_{y_{\text{max.}}} &= \pm 0.49 \text{ mm}, \\ \sigma_{z_{\text{max.}}} &= \pm 0.97 \text{ mm} \end{aligned}$$

Even though the results fell far short of the required accuracy level, the attainable precision permitted the use of the photogrammetrically deduced data for the determination of the x - and y -in-plane displacements in all ranges of loading, and the z -deformations in the plastic range only. The structural group considered the accuracy of z much too coarse for use in the evaluation of the deformations and the deduction of the curvatures in the elastic range of loading.

4. THEORETICAL STUDIES

Theoretical investigations were conducted in an effort to explore all the avenues to increase the accuracy of the stereometric system to allow full utilization of the photogrammetrically deduced deformations. It was obvious from the start that the rather weak B/D ratio (Base \div Object Distance) in the SMK-40 system (approximately $1 \div 6$ at best) played a major part in the rather poor results obtained. Of interest to us in the theoretical studies was to explore the effect on the precision of the observations and the overall accuracy of the system caused by: (a) change in base length; (b) convergence between the optical axes of the stereometric camera chambers; and (c) tilt in the optical axes of the stereometric camera.

The theoretical studies were based on mathematical models simulating stereometric coverages computed for a fictitious stereometric camera (essentially composed of the metrical chambers of the Zeiss SMK-40 and allowing degrees of freedom for convergence, tilt and base length). The object was assumed to have the same dimensions (84×42 inches) as the slab mentioned in Section 3, and was given a vertical position rather than the horizontal position under which the slab was tested and photographed. The convergence angle (γ in Figure 8) was varied between 0

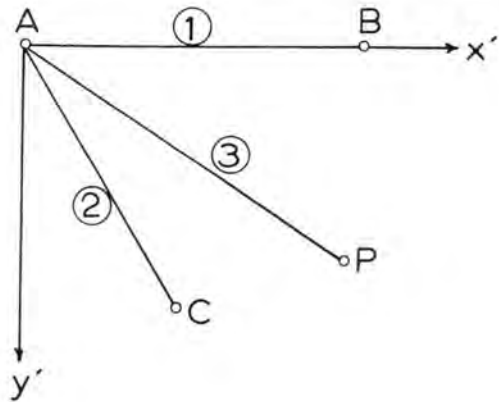

FIG. 7. "Floating" control for coordinate transformation.

and 120° at 10° intervals by varying the ϕ -tilt angles (ϕ_L and ϕ_R in Figure 8) between 0 and 60° at 5° intervals, keeping $\phi_L = \phi_R = \gamma/2$, and $D_L = D_R$ in all cases. The Ω -tilt angle (Ω in Figure 9) was varied between 0 and 90° at 10° intervals. Normal cases were investigated with base lengths (B in Figure 10) of 40, 80, and 120 cm.

The geometrical characteristics of the metrical chambers of the ZEISS SMK-40, the minimum focussing distance recommended by the manufacturer, and depth perception of the chambers, as well as the dimensions of the object were considered for the determination of the base length B and the object distance D in each situation. In the convergent cases, the shortest ray to the object was empirically placed at half the convergent angle. For each case, the standard errors of parallax measurements m_a , and that of pointing m_i were experimentally determined on actual photography.

It was of interest to note that our equations differ only slightly from the equations derived by Zeller (Baschlin and Zeller, 1934, pp. 209-222) for the same purpose. Even though the results obtained by our equations did not show a substantial increase in accuracy to warrant the replacement of Zeller's equations, we did use our equations in the error analysis for the sake of statistical perfection.

In case of convergent photography, our equations were used after properly deducing the angle ϕ_m (Figure 11). In such cases, the camera coordinate system was redefined as having its xz -plane formed by the x -axis of the left plate and the left chamber optical axis. (See Figure 12 also.) In case of this oblique photography, our equations ob-

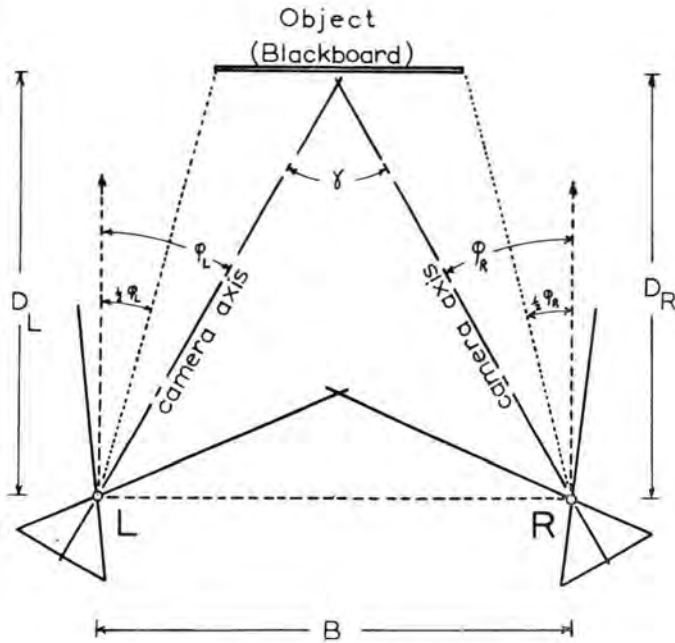

FIG. 8. Convergent stereometric coverage.

viously are referred to an inclined coordinate system (x, y, z in Figure 13). The values for m_x'' , m_y'' , and m_z'' were determined through the well known "pedal curve" (Jordan-Eggert 1948).

For each case, the theoretically expected standard deviations in $x, y,$ and z were determined. A full account of the results are to be given in a publication currently in prepa-

ration (Karara et al., 1968). A summary of the results is given in a table in that publication and partially shown graphically in Figures 16, 17 & 18.

As mentioned above, estimates for m_1 and m^2 were obtained experimentally. These values were deduced for each case from 25 independent STK-1 observations on each of 3 targets. A table in the reference publication lists the results obtained in the nine cases tested. For the other 23 cases, which have not

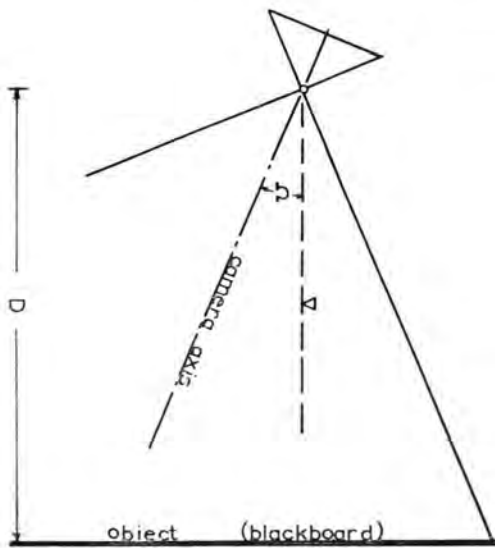

FIG. 9. Tilted photograph.

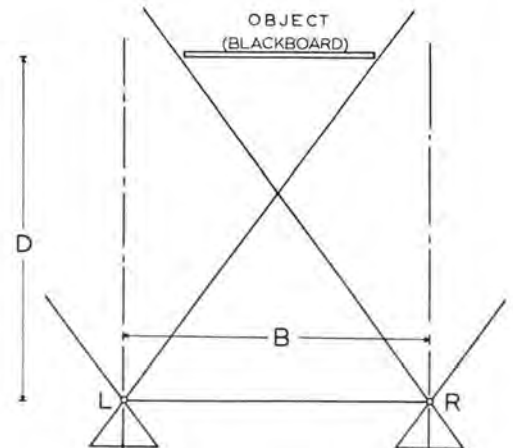

FIG. 10. The "normal case" of stereometric photogrammetry.

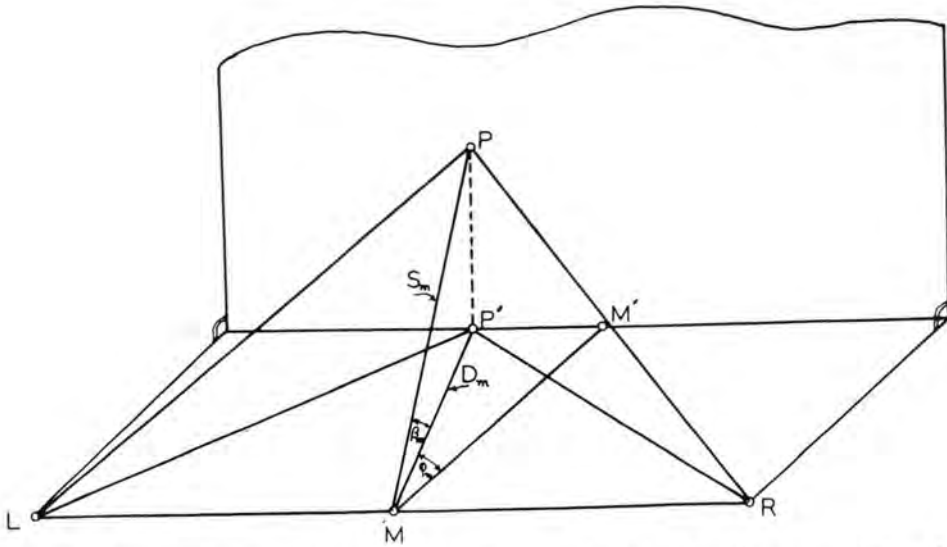

FIG. 11. A schematic diagram relating the position of a general point P to the camera stations L and R . The base $L-R$ is assumed to be horizontal. M is the mid-point of the base, and LRM' is a horizontal plane through L, R , and M . P' is the foot of the perpendicular from P on the plane LRM' .

yet been experimentally tested, the values given in the table were derived on the basis of assumed values for the parallax and pointing standard errors:

$$\begin{matrix} m_1 = 5.4'' & m_t = 1.58 \mu \\ m_2 = 4.2'' & m_a = 1.23 \mu \end{matrix}$$

These assumed values are actually the averages of the experimentally determined values in the tested cases.

5. EXPERIMENTAL INVESTIGATIONS
(THE BLACKBOARD TEST)

In order to substantiate the drastic increase of accuracy caused by convergence, tilt, and base-length increase as suggested by results of the theoretical investigations, a series of experimental tests were conducted. A portion (42x84 inches) of a vertical black board (equivalent to the size of the model slab mentioned in Section 3 of this paper) was covered with a multitude of individual

targets totalling 195 in number (Figure 14). The targets varied in type and size such that data with regard to the optimum target characteristics could also be gleaned through this experiment. Figure 15 shows the various types and sizes of the target used. Various sizes of identification (shown in Figure 15) were also used to experimentally settle the question of the optimum size of such numbers.

The ZEISS SMK-40 was used in the experiment. Normal cases with $b=80$ cm and $b=120$ cm, as well as the convergent photography, was simulated using only one of the SMK-chambers at a time. The distances and

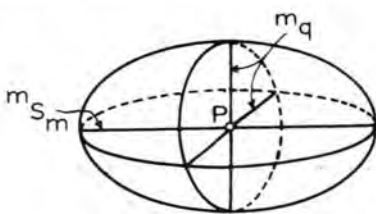

FIG. 12. The ellipsoid of errors. Point P corresponds to point P in Figure 11, and m_{sm} is in the direction of MP in Figure 11.

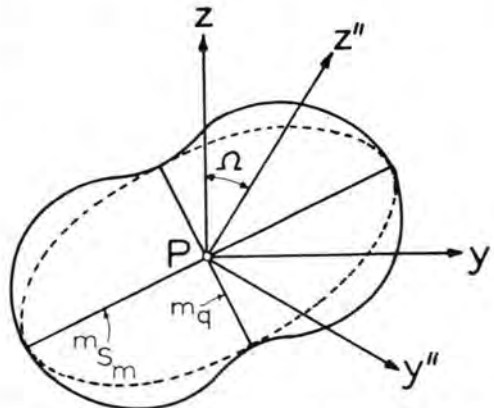

FIG. 13. Ellipse of errors and Pedal Curve for oblique photography.

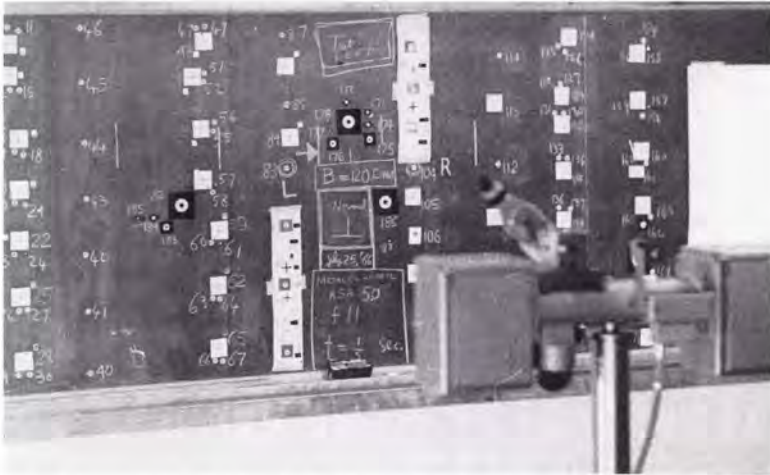

FIG. 14. View of the blackboard test with the Zeiss SMK-40 Stereometric Camera in the foreground.

angles were observed. For each case, five independent stereomodels were obtained.

In order to include some indications in this paper about the experimentally experienced increase of accuracy, ten targets of type No. 1 (refer to Figure 15) were chosen out of the 195 targets for a partial test. These targets were located throughout the test area. Three independent observations were made in the WILD STK-1 Stereocomparator on each of ten targets in each of the five models in each of the nine cases tested (three normal cases and six convergent cases). The model coordinates of the first model of each case were considered as reference, and the successive models were transformed into the *reference* model using four points chosen as *fixed control*. The standard errors are shown graphically in Figures 16, 17, and 18.

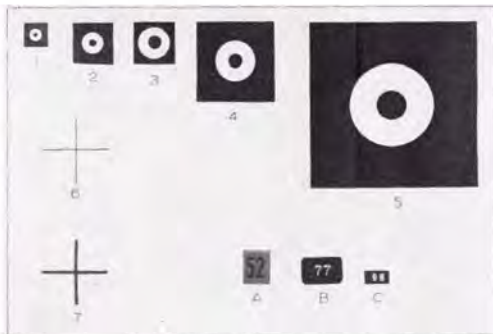

FIG. 15. Types of targets and identification numbers used in the blackboard test. All targets were photographically reproduced, with the exception of Target No. 3 which was a gummed reinforcement for notebook paper. The actual sizes were 3.5 times that shown here.

Figure 19 shows the standard errors experienced in photogrammetrically determined distances in the various cases tested so far. These values are based on ten distances determined five times each in each of the nine tests. In this case, the first *normal-case* model taken with $B = 120$ cm was chosen as reference and the coordinates obtained in all the other models were transformed into the reference coordinate system. This transformation simulates the regular absolute orientation.

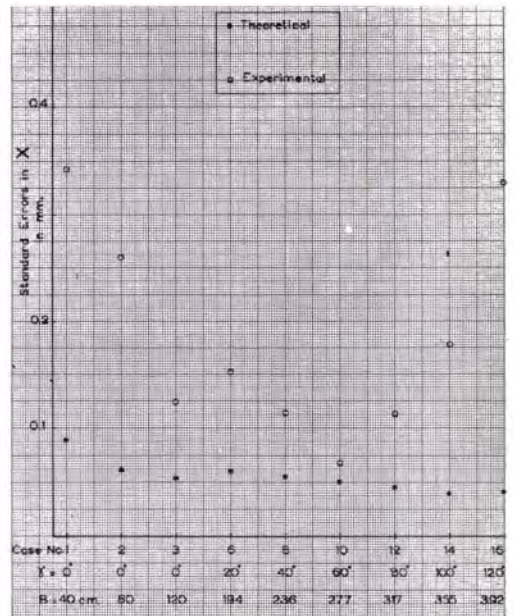

FIG. 16. Theoretically expected and experimentally obtained standard errors in X (model coordinate system).

Currently (mid-December 1966), a trilateration of high precision is being conducted to determine the relative positions of the various test points. The photogrammetrically determined distances between the various test points will then be compared to the trilaterated ones in order to determine the absolute accuracy of photogrammetrically determined distances.

It might be of interest to point out that the data processing was undertaken on the

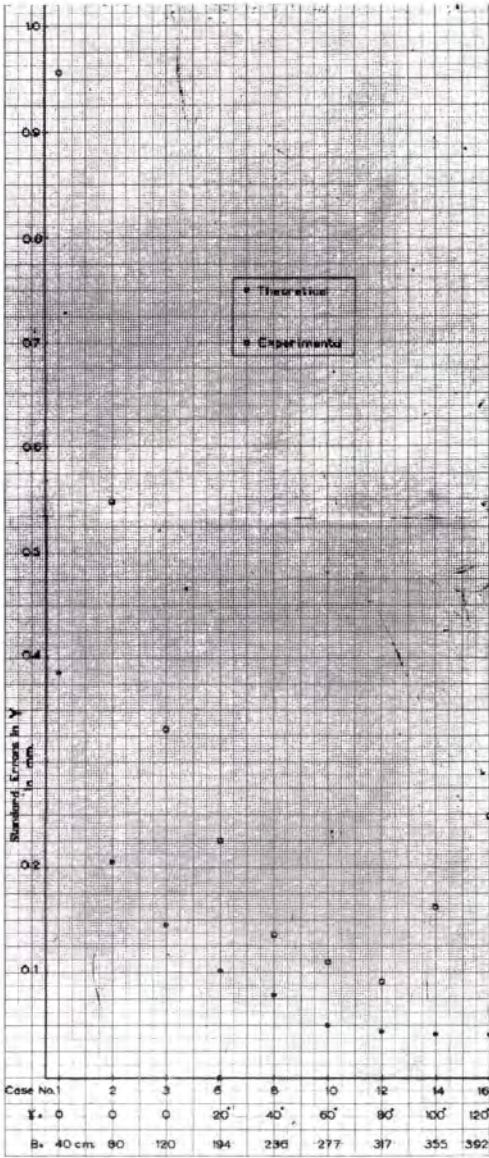

FIG. 17. Theoretically expected and experimentally obtained standard errors in Y (model coordinate system).

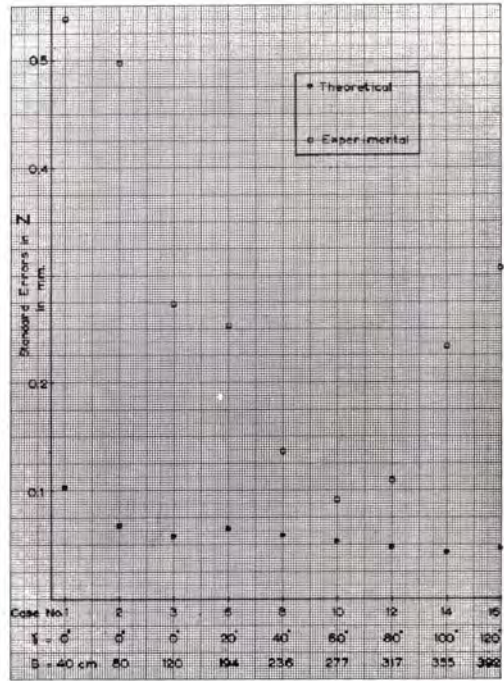

FIG. 18. Theoretically expected and experimentally obtained standard errors in Z (model coordinate system).

Illiac II ultra high-speed computer designed and built at the University of Illinois. The computer program included phases for image

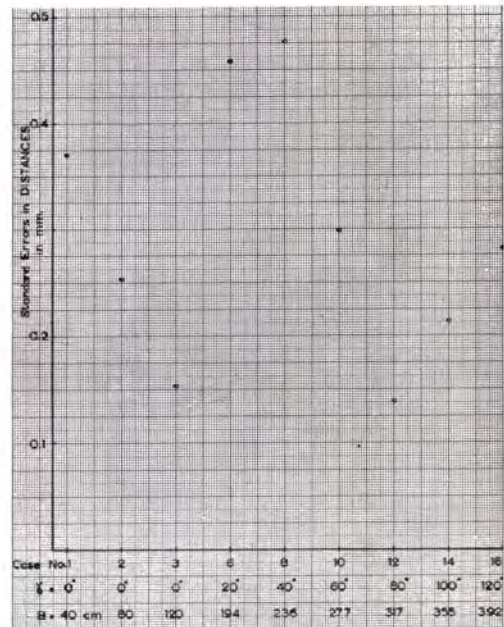

FIG. 19. Experimentally obtained standard errors in photogrammetrically determined distances.

coordinate refinement, relative orientation, absolute orientation (or three-dimensional conformal transformation), and error analysis. To eliminate the influence of round-off errors and the loss of significance, double-precision arithmetic was employed at critical points in the program (image coordinate refinement, three-dimensional transformation, and computations of distances). It should be noted that computer programs used on the Iliac II could be used also for IBM 7094 without major changes. Full details about the program are to be included in a report currently in preparation (Karara *et al.*, 1968).

5.1. DISCUSSION OF THE RESULTS

Obviously no final conclusions could be made at this time with only a part of the observational program completed, and with the bulk of the analysis of the data still unaccomplished. However, it might be of interest to note the following indications suggested by the results obtained so far, keeping in mind, of course, that no generalization is possible at the present stage, particularly because practically only one operator has been involved so far (a second observer was used only to check on key measurements but not to reundertake the entire program of observations; this, however, is planned for a later date).

As fully expected, a substantial increase in precision of coordinates and distances is experienced with the improvement of the $B \div D$ ratio.

A substantial increase in precision of the system is experienced as the convergence (γ) is increased from 0° to 60° .

Convergence angles of more than 60° do not seem to be recommendable in view of the apparent decrease in accuracy in these cases. This might be mainly due to the unfavorable angle at which the circular targets are photographed. This tendency, however, has not been detected either in the pointing and parallax errors or in the theoretically expected results partially shown in Figure 16, 17, and 18.

The optimum angle of convergence in our specific case seems to be in the neighborhood of 60° .

No satisfactory explanation could be given at this time for the apparently big differences between the theoretically expected and the experimentally determined values for the standard deviations of the photogrammetrically deduced coordinates. The trends in both approaches, however, seem to satisfactorily confirm each other.

6. UNIVERSAL STEREOMETRIC SYSTEM

Based on the above listed indications, and assuming that the results of the full test will confirm the results and indications of the

partial test, and keeping in mind some of the difficulties encountered in operating the ZEISS SMK-40, the following characteristics and capabilities are deemed very desirable in an ideal universal stereometric system.

- Base length changeable at will.
- Convergence between the chamber optical axes to be introduced and changed at will.
- General and differential tilt of the chambers optical axes to be introduced and changed at will.
- Possibility of rotation of the stereometric camera around its vertical axis. Also important is a possibility of locking and retaining the base at any desired position.
- Interchangeable metrical chambers for various ranges of object distance (e.g., a set for distances between 50 and 5 meters, another set for the range 10 to 2 meters, and other sets to cover the very short range, say 2.5 to 0.5 meters).
- The individual chambers and lenses should be of very high quality. The characteristics of such items should be made known to the user of the camera. (This is usually not the case with the currently available stereometric cameras).
- Provisions for a viewfinder in each of the two metrical chambers, and the incorporation of both view finders in a binocular-type viewing device that would allow accurate assessment of the stereoscopic coverage before the photographs are taken.
- The price of such a universal stereometric system does not need to be astronomically high. With the exception of the metrical chambers, which should be of the highest quality and performance, the provisions suggested and listed above do not need to be of ultra-high precision. In the phase of data reduction, analytically or according to an analogue approach, it suffices in most cases to have good approximations for the parameters of the outer orientation. This remark is, of course, not valid in case of the few simplified restitution equipment designed specifically for the normal case of photogrammetry.

The eight capabilities listed above are presented from the point of view of the user of stereometric cameras, without being restricted by eventual manufacturing difficulties or policies. These ideas are presented with the hope that a universal stereometric system will be materialized in the not too distant future.

It is our conviction that the market is ripe for a universal stereometric system, and that the introduction of such a camera will have far reaching impact in many engineering and scientific disciplines.

REFERENCES

- Apostol, T. M., 1962. *Calculus* (Vol. I). Blaisdell Publishing Company, New York, 515 pp.
 Baeschlin, C. F., and Zeller, M., 1934. *Lehrbuch der Stereophotogrammetrie*. Orell Fussli Verlag, Zurich, 515 pp.

- Jordan, W., and Eggert, O., 1948. *Handbuch der Vermessungskunde* (Part 1). Metzlersche Verlagsbuchhandlung, Stuttgart, 632 pp.
- Karara, H. M., Marks, G. W., Beneš, M., and Moellman, D. E., 1968 (expected). *Stereometric Systems for Close Range Photogrammetry*. Civil Engineering Studies, Photogrammetry Series, University of Illinois, Urbana.
- Konecny, G., 1965. Structural Engineering Application of the Stereometric Camera. *Photogrammetric Engineering*, 31: 96-103.
- Kowalczyk, Z., 1964. Stereofotogrametryczna Dokumentacja Wypadkow I Awarii Kopalniowych, *Biuletyn Polskiego Towarzystwa Fotogrametrycznego*, pp. 177-182.
- Lenschow, R. J., and Sozen, M. A., 1966. *A Yield Criterion for Reinforced Concrete Under Biaxial Moments and Forces*. Civil Engineering Studies, Structural Research Series No. 311, University of Illinois, Urbana, 527 pp.
- Wasil, B. A., and Merchant, D. C., 1964. Plate-Deflection Measurements by Photogrammetric Methods. *Experimental Mechanics*, 5: 77-83.
- Wood, R. H., 1961. *Plastic and Elastic Design of Slabs and Plates*. The Ronald Press Company, New York, 344 pp.

XI CONGRESS ISP, LAUSANNE, SWITZERLAND

Here are brief samples of the package tours that are described more completely on page 1193 of the October issue of PHOTOGRAMMETRIC ENGINEERING:

PACKAGE No. 1, July 6. Depart New York, N. Y.; July 8-19, XI Congress Lausanne; 20-27 July, Genoa, Pisa, Florence, Rome, Sorrento, Naples; July 27, N. Y. \$695.00; Children (2-12 years) \$523.00

PACKAGE No. 2, July 6. Depart New York, N.Y.; July 8-19, XI Congress Lausanne; July 20-27, Blackforest, Heidelberg, Luxembourg,

Brussels, Amsterdam, Hook of Holland, Harwich, London; July 27, N.Y. \$665.00; Children (2-12 years) \$519.00.

PACKAGE No. 3, July 6. Depart New York, N.Y.; 8-19 July, XI Congress to Montreux, Castle of Chillon; 21 July, N.Y. \$450.00; Children (2-12 years) \$305.00.

PACKAGE No. 4, July 5. Depart New York, N.Y.; July 7-19, XI Congress Lausanne; 20-28 July, make your own arrangements at your own expense; 28 July, board flight for N.Y. in either Geneva or London. \$525.00; Children (2-12 years) \$335.00.

RESERVATION REQUEST FORM

TO: Mrs. Walter H. Katherman, Jr., American Express Tour Department
622-14th Street, N. W., Washington, D. C. 20005

Please confirm _____ reservations for package no. _____.

Enclosed is deposit* in the amount of \$_____ as requested.

For: Mr. _____

Mrs. _____

Miss _____

Please indicate ages of children if applicable.

* (Checks to be payable to AMERICAN EXPRESS COMPANY)

Travel arrangements covered by:

_____ Government or AGU grant or Government Contract

_____ Government T/R

_____ Personal or other funds.

Please confirm connecting flight reservations for _____ persons.

From _____ to New York (J.F.K.)

From New York to _____

In connection with package selected.

Name: _____

Address: _____

City: _____ State: _____ Zip: _____